

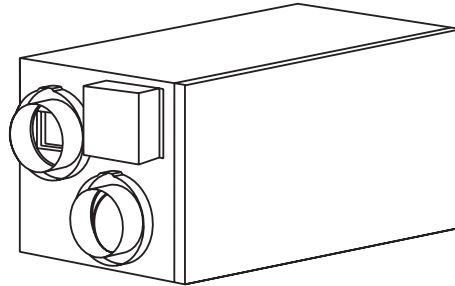

User's Information Manual



ERVCLHA Horizontal Unit

A07619

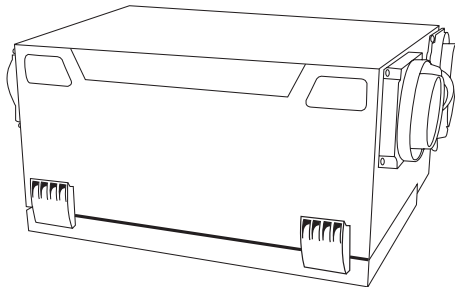

ERVCCSHA Unit (Side Port)

A05330

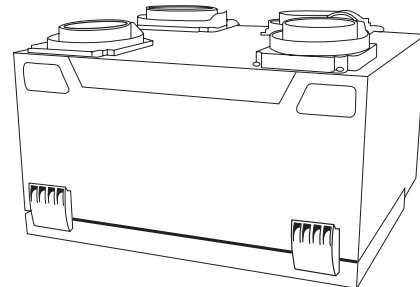

ERVCCSVA Unit (Top Port)

A05229

NOTE TO EQUIPMENT OWNER:

For your convenience, please record the model and serial numbers of your new equipment in the spaces provided. This information, along with the installation data and dealer contact information will be helpful should your system require maintenance or service.

ENERGY RECOVERY VENTILATOR

Model # _____

Serial # _____

ACCESSORIES (List type and model #)

INSTALLATION INFORMATION:

Date Installed _____

DEALERSHIP CONTACT INFORMATION:

Company Name _____

Address _____

Phone Number _____

Technician Name _____

NOTE TO INSTALLER:

This manual must be left with the equipment owner.

SAFETY CONSIDERATIONS

Recognize safety information. This is the safety-alert symbol . When you see this symbol on the unit and in instructions or manuals, be alert to the potential for personal injury. Understand these signal words; DANGER, WARNING, and CAUTION. These words are used with the safety-alert symbol. DANGER identifies the most serious hazards which **will** result in severe personal injury or death. WARNING signifies hazards which **could** result in personal injury or death. CAUTION is used to identify unsafe practices which **would** result in minor personal injury or product and property damage. NOTE is used to highlight suggestions which **will** result in enhanced installation, reliability, or operation.

UNIT OPERATION

ERV with OneTouch™ Control

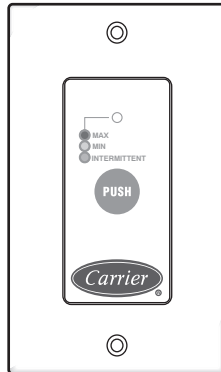

A07622

Press “PUSH” until the desired ventilation operation is selected. There are three selections: High, Low, Intermittent. The power indicator light indicates which mode has been selected.

High — This mode is recommended for the removal of excess pollutants and humidity. The ventilator will operate at its maximum speed continuously. The power indicator light will be lit red when this mode is selected.

Low — This mode is recommended for normal daily operation. The ventilator will operate at its minimum speed continuously. The power indicator light will be lit yellow when this mode is selected.

Intermittent — This mode is recommended when the inside air is too dry in the heating season or too humid in the cooling season. The ventilator will operate at its minimum speed for 20 minutes per hour and be off for 40 minutes per hour. The power indicator light will be lit green when this mode is selected.

Off — To turn the ventilator off, press “Push” until the power indicator light is turned off.

ERV with Latent Control

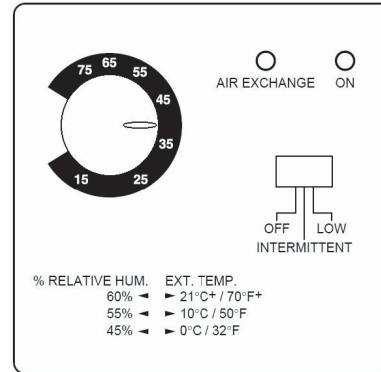

A07621

Your ERV is designed to operate as an integral part of your total heating and cooling system.

Low Exchange Mode—If the relative humidity inside the building is lower than selected, air exchange would occur with the outside at high speed. If the relative humidity level inside the building is higher than selected, air exchange would occur outside at low speed. This ensures continuous air exchange for constant air quality.

Intermittent Mode—If the relative humidity inside the building is higher than selected, no air exchange would occur, and the system would turn off. If the relative humidity inside the building is lower than selected, air exchange would occur with outside at high speed. This mode is ideal for maintaining the proper humidity level when the continuous mode cannot.

WARNING

ELECTRICAL SHOCK HAZARD

Failure to follow this warning could result in personal injury or death.

Before servicing system, always turn off main power to system. Turn off accessory heater power if applicable. There may be more than 1 disconnect switch.

CAUTION

PERSONAL INJURY HAZARD

Failure to follow this caution may result in personal injury.

Although special care has been taken to minimize sharp edges in the construction of your unit, be extremely careful when handling parts or reaching into the unit.

MAINTENANCE

1. The motors are factory lubricated. Lubricating the bearings is not recommended.
2. The core should be vacuumed every three months to remove dust that would inhibit the energy transfer. **Do not use water. The core should only be serviced when the outdoor temperature is between 60°F (16°C) and 75°F (24°C) and dry.**

NOTE: If the edges of the core are soft, do not try to service the core. The air passages can be damaged and/or closed off by handling it or trying to remove it.

3. A dirty air filter will cause excessive strain on the blower motor. The filters in your ERV are washable and should be cleaned every 3 months. Use a vacuum cleaner to remove the heaviest portion of accumulated dust, then wash in warm water.

NOTE: Do NOT clean these filters in a dishwasher or dry them with heating appliances as they will be permanently damaged. Use lukewarm water to clean filters. Replace filters only when they are completely dry.

4. Regularly check the screen on the exterior intake hood and clean as necessary.

BEFORE YOU REQUEST A SERVICE CALL

- Check the main power disconnect switch. Verify that the circuit breakers are ON or that fuses have not blown. If you must reset breakers or replace fuses, do so only once. Contact your servicing dealer for assistance if the breakers trip or the fuses blow a second time.
- Check for sufficient airflow. Check air filters for accumulations of large particles. Check for blocked exhaust-air grilles or ductwork. Keep grilles and duct work open and unobstructed.
- Check to see if the unit is calling for air exchange, or unit is in defrost. When outdoor ambient temperature is below 23°F (-5°C), some degree of defrost mode is possible. Defrost length could be 5 to 20 minutes, depending on temperature and settings.

If your ERV still fails to operate properly, contact your servicing dealer. Give him your model and serial number. With this information, the dealer will be able to correct any problems.

ERV

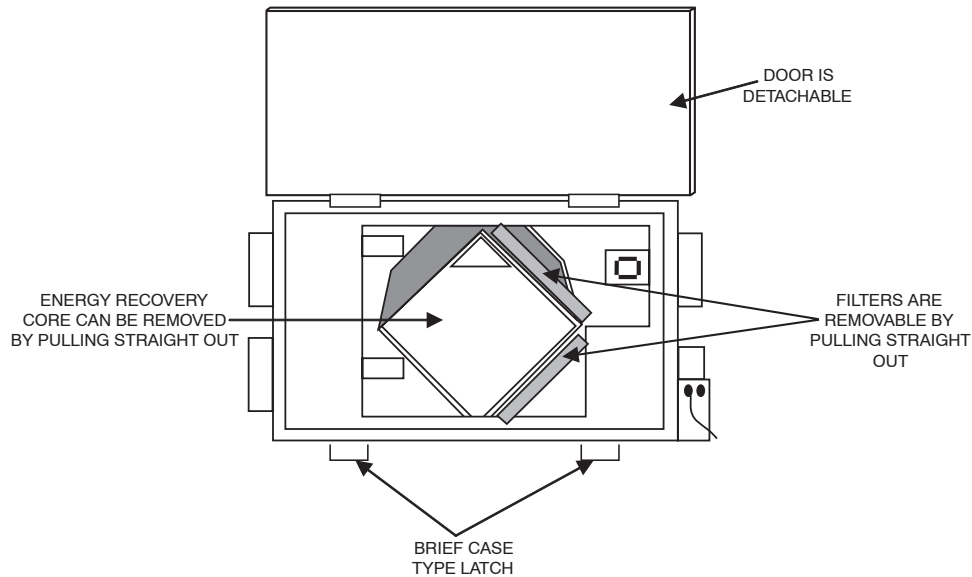

Horizontal Application

A99300



HEATING & COOLING

TO OBTAIN INFORMATION ON PARTS: Consult your installing dealer or classified section of your local telephone directory under the "Heating Equipment" or "Air Conditioning Contractors & Systems" heading for dealer listing by brand name.

Have available the Model No., Series Letter, & Serial No. of your equipment to ensure correct replacement part.

Carrier Corporation • Indianapolis, IN 46231

Manufacturer reserves the right to change, at any time, specifications and designs without notice and without obligations.